

iGarden

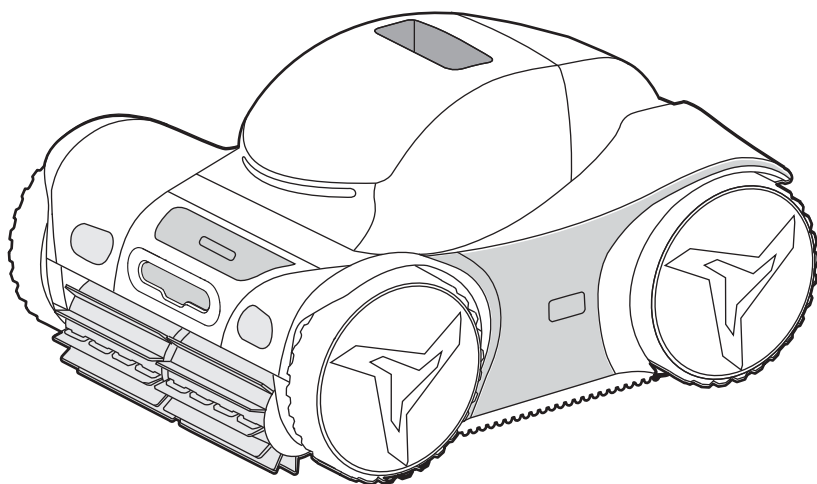

iGarden Pool Cleaner M1 AI

— USER MANUAL —

Please read this manual carefully before installing and operating your pool cleaner, and keep this manual for future reference to ensure safe and effective use.

Table of Contents

1 Introduction	01
-----------------------	----

2 Important Safety Information	01
---------------------------------------	----

2.1 Warnings

2.2 Operating Conditions

3 What's in the Box	02
----------------------------	----

4 Getting Started	03
--------------------------	----

4.1 Charge

4.2 Assemble Parts

4.3 Quick Start

5 Learning The Control Panel	05
-------------------------------------	----

5.1 Control Panel Overview

5.2 Control Panel Details

6 Connect To WiFi	06
--------------------------	----

7 Care And Cleaning

07

7.1 Filter Box

7.2 Bionic AI Dual-Camera

7.3 Impeller

7.4 Roller Brush

7.5 Tires

7.6 Battery

8 Troubleshooting

11

9 Cleaner Specifications

13

10 Regulatory & Compliance

15

11 Warranty

16

12 Support

16

1 Introduction

Thank you for purchasing the iGarden Pool Cleaner M1 AI. Reading and following instructions provided is crucial for a better user experience.

2 Important Safety Information

2.1 Warnings

Failure to comply with the instructions can result in injury, damage to the product or other property.

- **Designed for pools.** Use only to clean your pool. The cleaner is intended for residential use.
- **Children.** Keep children away from the cleaner. Individuals with reduced physical or mental abilities should not use it without supervision.
- **Proper installation is required.** Please follow the country's local installation standards. Damage from an incorrect installation is not covered by the warranty.
- **Do not enter the pool while the cleaner is running.**
- **Charging.** Use only the power supply and charge at least 3.5 meters (11.48 ft) away from the pool. If you notice anything unusual while charging, for example a strange smell, unplug it immediately and contact us.
- **Cleaning and maintenance.** Turn the cleaner off and unplug it before cleaning and maintenance. Only use original replacement parts from the manufacturer.
- **Control panel.** Make sure your hands are dry when using the control panel.
- **Repair.** Do not attempt to repair the device yourself, please contact us instead.
- **Using conditions.** The cleaner is recommended to be used in water deeper than 40 cm (1.31 ft) to protect its motor. When the battery level is below 30%, this cleaner will switch to floor-only cleaning mode. While cleaning the pool floor, it cannot traverse cross-slopes steeper than 30 degrees. Do not run the cleaner while adding chlorine to the water. Do not use this product during thunderstorms or bad weather.
- **Storage.** Do not expose this product to rain or direct sunlight for extended periods. Clean and dry the product after each use before storage. For long-term storage, unplug and neatly store the charger cable to prevent damage. Keep your cleaner in a cool, dry place with temperature between -10 to 45 °C (14 to 113 °F) and humidity between 30% to 70%.

- **Handling.** Lift the cleaner out gently. After removal, keep it in an upright position to drain water before storing it flat. Never lift the cleaner out of the pool by a slide rod, as it may damage the product.

2.2 Operating Conditions

Parameter	Range
Working Water Depth (m)	1-2.5 m / 3.3-8.2 ft
Pool Water Temperature	4-35 °C / 39.2-95 °F
pH level	7.0-7.8
Sodium Chloride Concentration (PPM)	Maximum = 5000 PPM
Chlorine Content (PPM)	Max 4 PPM

💡 NOTE:

The battery life of this product may be reduced if the pool water temperature is below 15 °C / 59 °F.

3 What's in the Box

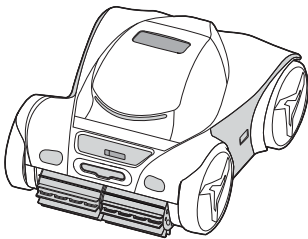

Pool Cleaner

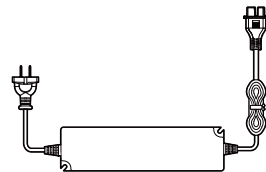

Charger

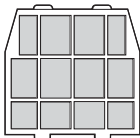

Filter

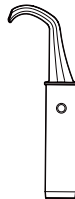

Hook

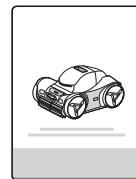

Manual

💡 NOTE:

The packaging of this product includes the following items. If there is any damage or missing parts, please contact the retailer.

4 Getting Started

4.1 Charge

Uncap and plug the included charger into a power outlet (100-240 V). Seeing all three indicator lights on, unplug and cover the cap back.

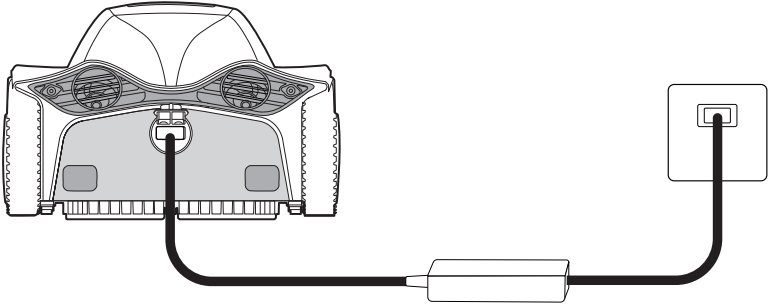

4.2 Assemble Parts

Attach the hook to the extension pole (Not included in the package).

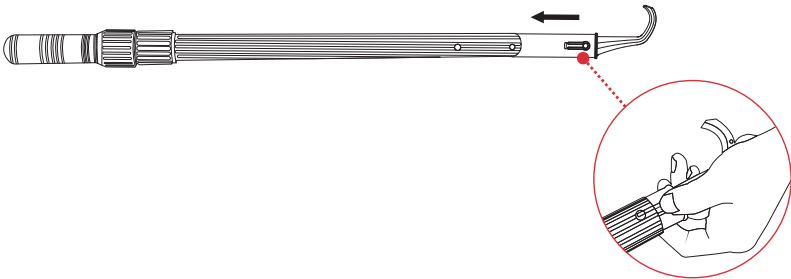

4.3 Quick Start

Switch the cleaner on.

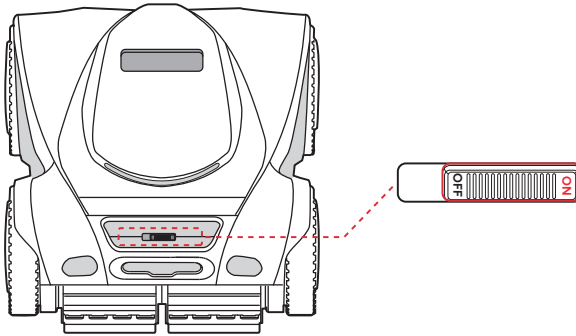

Place the robot in water, hold it and rotate the cleaner to let the air escape. See image below:

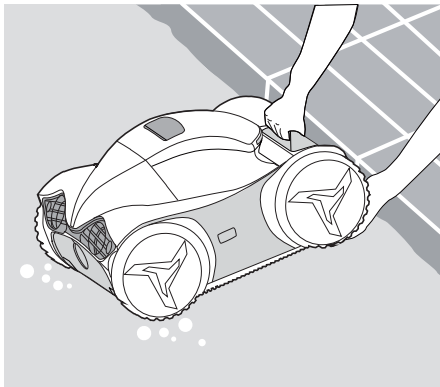





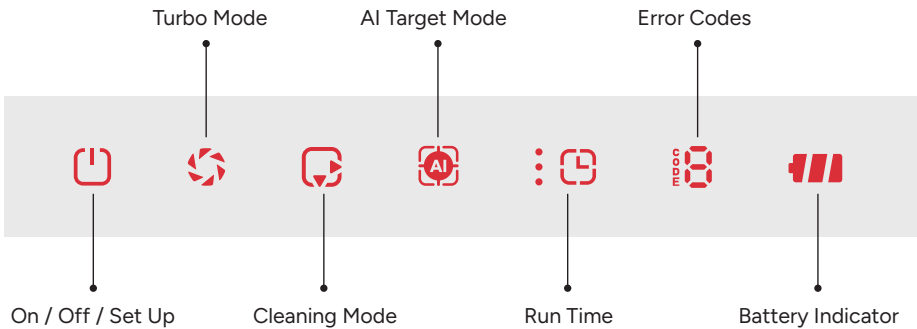

 **NOTE:**

Make sure it is submerged under water within 3 minutes after turning on, or it will automatically stop.

5 Learning The Control Panel



5.1 Control Panel Overview

Button	Icon	Effects	Function
On / Off / Set Up		Light Flashes / On	Setup / Operation Starts
Run Time		1 / 2 / 3 LEDs or Off	1 h / 1.5 h / 2 h or Low Battery
Cleaning Mode		Bottom LED On	Floor Only (S-Path Cleaning first, then AI Target)
		Top LED On	Wall & Waterline Only
		*Both LEDs On	*Wall & Waterline first. Then Floor cleaning: S-path → AI Target
		*Both LEDs Off	*Full Coverage
AI Target Mode		LED On / Off	AI Target Mode (Floor Only) On / Off
Turbo Mode		LED On / Off	Turbo Mode On / Off
Error Codes		E1–E7	System Fault (see Troubleshooting)
Battery Indicator		LEDs On / Flash	20-100% Battery Levels / Charging

Important Cleaning Modes Explained*Wall & Waterline first, then Floor**

Recommended for most cleaning needs; Does not clean tanning ledges or other shallow areas.

Full Coverage

Cleans Floor → Wall → Waterline to cover all areas (Includes tanning ledges); May use more power than Wall & Waterline first, then floor.

5.2 Control Panel Details

Function	Condition	Response
Turn On Hold	3 s	Wake and Start Setting
Turn On Tap	After Setting	Save Setting and Auto-clean In Water
Preset Run Cycle	Tap AI timer button	Clean and stop until the first cleaning cycle is done. Auto-clean again after a 24 h interval.
Low Battery	LED Flashes	< 15% Power Levels Parks and Stops

6 Connect To WiFi

Hold Cleaning Mode for 3 s. When you hear a tone, it is ready to pair. Connect device to network in the "iGarden" App before placing it into the water. Once the Control Panel lights up, the WiFi is set. Scan the QR Code below to download:



7 Care And Cleaning

7.1 Filter Box

1. See the filter basket.
2. Lift the handle to remove the filter basket.
3. Open and separate the double-layer filter box.
4. Rinse the filter box.
5. Align upper clips with the matching slots to restore the filter box.
6. Slide into bottom slots until it clicks into place.

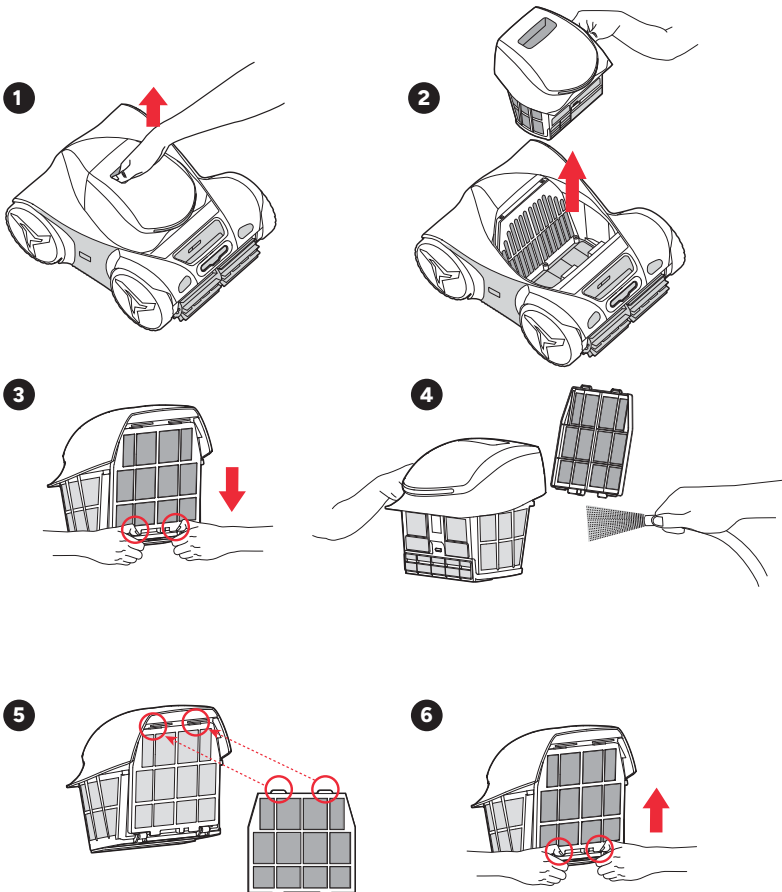

 **NOTE:**

1. The robot comes equipped with a single-layer filter by default, which is generally sufficient for daily cleaning.
2. When dealing with fine debris such as sand, dirt, or settled dust, it is recommended to perform an initial clean with the single-layer filter first, then switch to the double-layer filter for a thorough clean to achieve optimal results.

7.2 Bionic AI Dual-Camera

AI Target Mode (Only Active During the Floor Cleaning Phase)

1. Floor Only

The cleaning mode indicator and the bottom triangular indicator light up. Based on the set cleaning time (e.g., 1 hour), the robot follows an S-shaped cleaning pattern for the first 2/3 of the cycle (about 40 minutes) to cover the entire floor, then switches to AI Target for the final 1/3 (about 20 minutes). The camera starts detecting remaining debris and performs targeted touch-up cleaning.

2. Wall & Waterline Only. Then Floor cleaning

The cleaning mode indicator and both triangular indicators light up. After the robot finishes cleaning the walls and waterline, it switches to Floor Only. It performs S-path floor coverage cleaning for the first 2/3 of the cycle, then automatically enables AI Target for the final 1/3, using Bionic AI Dual-Camera to continuously identify remaining debris and precisely target missed areas.

3. AI Target Only

Press the AI target mode and the multicolor indicator light turns on. In this mode, the robot runs AI Target for the entire cleaning cycle based on the set cleaning time.

After setting the AI target mode via the control panel or the app, the robot will begin cleaning the pool floor according to the preset cleaning path once it enters the water. During operation, the front camera automatically detects and locks onto debris ahead, performing targeted cleaning.

7.4 Roller Brush

Release tabs, slide on new brushes.

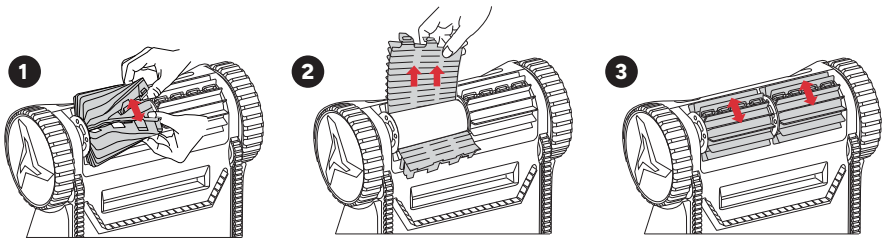

7.5 Tires

Remove the cap from the wheel, and replace the worn tire.

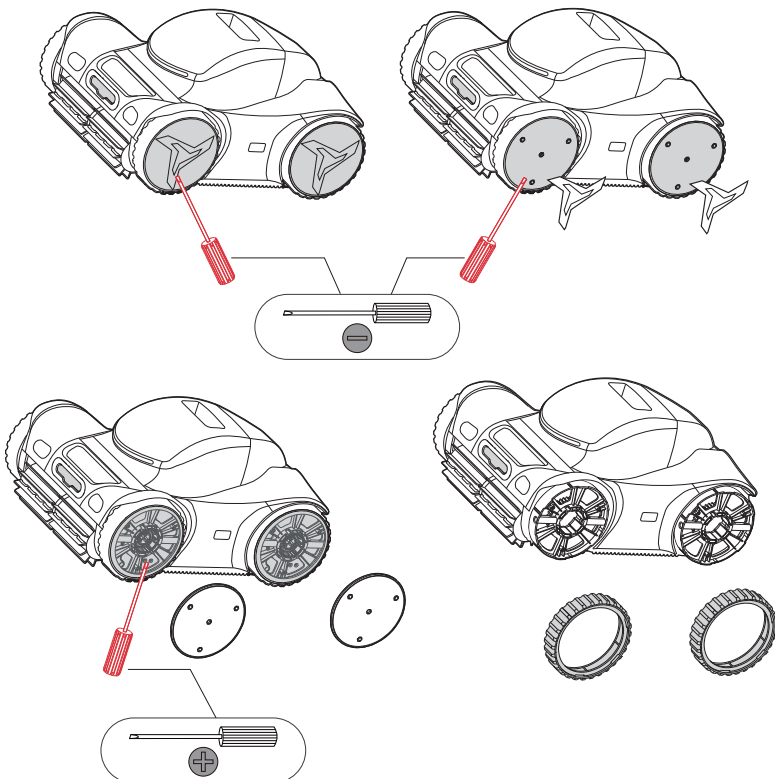

7.6 Battery

Fully charge the cleaner every 3 months.

8 Troubleshooting

Problem	Cause	Solution
Charging failure	Debris on the charging cable	Clean debris
	Charging cable damage	Replace charging cable
Startup failure	Invalid "Turn On" setting	Turn ON again
No Movement/ Pump	Control panel wet	Dry the panel and try again
	Wrongful operation	Restart the cleaner/ Reselect modes
	Low battery level	Fully charge
Moving but not pumping	Out of water	Submerge fully
	Turn on improperly	Turn it on after setup. LED ON indicates turning on successful
	Filter box full	Clean the box
	Impeller stuck	Clean debris in OFF state
Pumping but not moving	Filter box full	Clean the box
	Inlet clogged	Clean the inlet
	Low battery level	Fully charge
	Motion motor stuck	Contact us for motor replacement

Not climbing	Belt stuck	Adjust the belt
	Worn belt	Replace the belt
	Roller brush stuck	Clean the roller brush
	Obstacles blockage. Stop for protection setup	Clean the obstacles and restart the cleaner
	Filter box full	Clean the box
	Bottom cleaning mode	Switch modes
Poor cleaning	Impeller stuck	Clean debris in OFF state
	Filter box full	Clean the box
	Inlet clogged	Clean the inlet
	Low battery level	Fully charge
Abnormal operation	See potential causes identified in "Poor cleaning"	Fix the issue according to solutions listed in "Poor cleaning"
	Worn filter net	Replace the filter net
	Software glitch	Restart the cleaner
Error Codes	E1	Left Drive Motor Error
	E2	Right Drive Motor Error
	E3	Left Pump Error

Error Codes	E4	Right Pump Error
	E5	Infrared Sensor Error
	E6	Water Sensor Error
	E7	Motor Control Box Communication Error
Low-Temperature Protection	The robot cannot charge properly when the temperature is below -3°C.	Place the robot in an environment above -3°C for a period of time before charging to avoid reduced battery performance or abnormal charging caused by low temperatures.

9 Cleaner Specifications

Model	M1-60 AI	M1-80 AI	M1-100 AI
Battery Life: Floor Mode	6 h	8 h	10 h
Charging Time	Approx. 5 h	Approx. 6 h	Approx. 4.5 h
Battery Capacity	7,500 mAh (192 Wh)	10,000 mAh (255.5 Wh)	
Maximum Pool length	9 m (29.5 ft)	12 m (40 ft)	15 m (50 ft)
Optimal Pool Temperature	4~35 °C / 39.2~95 °F		

Cleaning Mode	Floor Only (S-Path Cleaning first, then AI Target)	
	Wall & Waterline Only	
	Wall & Waterline first. Then Floor cleaning: S-path → AI Target	
	Full Coverage	
Turbo mode	YES	
Multiple Cycle Option	1 h / 1.5 h / 2 h / Max	
AI Timer	24 h / 48 h / 72 h	
AI Camera System	Bionic AI Dual-Camera	
APP Application	YES	
Filter Capacity	4.5 L	
Filtration Accuracy	Double layers	
Pump Flow Rate	12-19 m ³ /h (3170-5019 GPH)	16-23 m ³ /h (4227-6076 GPH)
Running Power	20-100 W	
Moving Speed	12 m/min (39.4 ft/min)	
Number of Motors	4	
Charger Input	100-240 V AC~50/60 Hz	
Running Voltage / Current	25.2 V / 1 A	
Robot NW / GW	11.1 kg / 16.1 kg (24.47 lb / 35.49 lb)	11.5 kg / 16.4 kg (25.35 lb / 36.16 lb)

Product Dimensions (L×W×H)	507 × 392 × 249 mm (20.0 × 15.4 × 9.8 in)
Package Dimensions (L×W×H)	590 × 445 × 332 mm (23.2 × 17.5 × 13.1 in)

NOTE:

Tested in a pristine 3 × 8 m (9.8 × 26.2 ft) rectangular pool under controlled lab conditions. Actual battery life may vary with pool shape, size, and water quality. The manufacturer reserves the right to modify the above parameters without prior notice.

10 Regulatory & Compliance

Indoor Charging Only

Charge the cleaner indoors in a dry area away from direct sunlight.

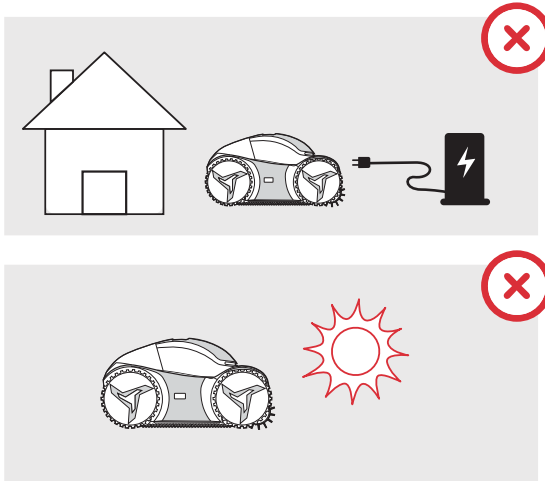

Battery Recycling

The unit contains a lithium-ion battery. Recycle batteries at qualified facilities.

Recycling batteries benefits the environment and public health. Do not disassemble or dispose of batteries in household trash or municipal recycling bins.

For complete regulatory statements (FCC Caution, FCC Statement, IC Statement) and manufacturer information, visit: <https://store.igarden.ai/pages/warranty-policy>



Situations Not Covered by Warranty

- Failure to comply with the instructions.
- Product damage caused by misuse or any reason other than manufacturer defects.
- Damage caused by cleaning and maintenance performed by unauthorized third parties.
- Batteries damaged by unauthorized third parties.
- Overcharging the battery using a non-specified input power cable.
- Using non-specified accessories that cause the product to malfunction.

11 Warranty

Full Unit (motor, battery, electronics): 3 years

Consumables (brushes, baskets, filters, tracks): 6 months

For complete warranty terms—including exclusions, service process, and limitations—please visit:
<https://store.igarden.ai/pages/warranty-policy>

12 Support



Email: support@igarden.ai (AU & US) support.eu@igarden.ai (EU)



Official Website: www.igarden.ai



Facebook: [iGarden](#)



Toll-free(US): (+1)888-880-3320 Toll-free(AU): (+61)1800-716-885

© 2025 iGarden All rights reserved. Version: M1 AI-Manual-V0 (EN)

Full legal terms and updated specs: <https://store.igarden.ai/pages/warranty-policy>

iGarden

 www.igarden.ai

Version: M1 AI-Manual-V0 (EN)

Thank you for choosing our Cordless Robotic Pool Cleaner.